





# Maestro 1

## Black door



A+

10  
years  
Guarantee

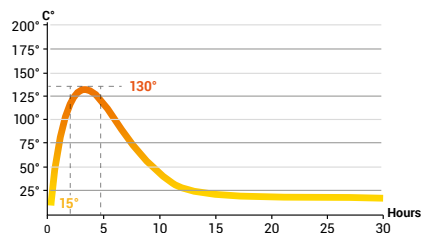

-  420 kg
-  12 Pa
-  6 kW
-  4-10 kW
-  30 - 120 m<sup>2</sup>



- Mg/M<sup>3</sup>** 31
-  1,7 kg
-  83,5%

 **LOTUS**  
QUALITY FIRST

# Maestro 1

## Black door

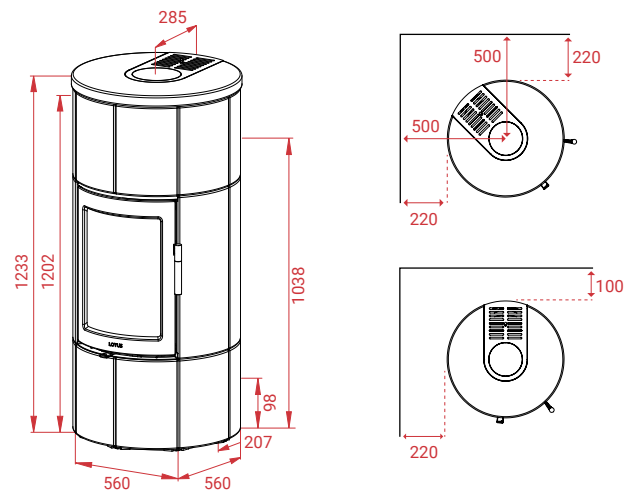

See the stoves online:



### Other models in the series:

- Maestro 1 Soapstone – Magic door
- Maestro 1 Indian Night
- Maestro 1 Indian Night – Magic door
- Maestro 2 Soapstone
- Maestro 2 Soapstone – Magic door
- Maestro 2 Indian Night
- Maestro 2 Indian Night – Magic door

### Accessories:

- Extra stones for rear exhaustion
- Shaped glass floor plate
- Universal glass floor plate black

 **LOTUS**  
QUALITY FIRST

**LOTUS HEATING SYSTEMS AS**

Tlf. +45 6323 7070

www.lotusstoves.com

Email info@lotusstoves.com





# Maestro 1

## Grey door



A+

10  
years  
Guarantee

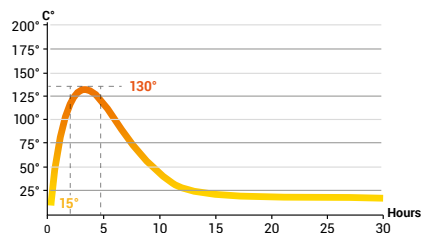

-  420 kg
-  12 Pa
-  6 kW
-  4-10 kW
-  30 - 120 m<sup>2</sup>



- Mg/M<sup>3</sup>** 31
-  1,7 kg
-  83,5%

 **LOTUS**  
QUALITY FIRST

# Maestro 1

## Grey door

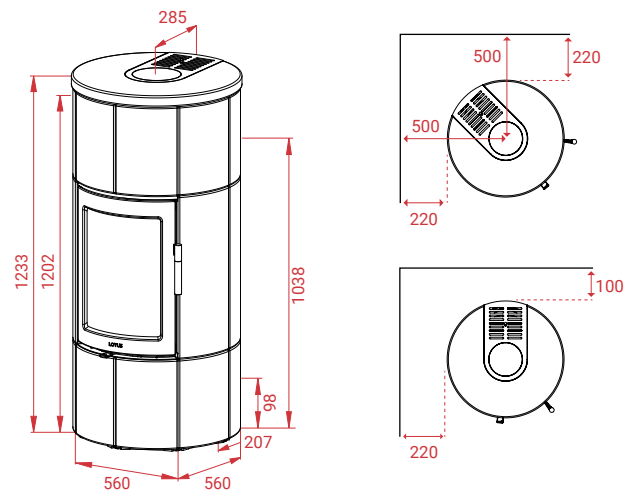

See the stoves online:



### Other models in the series:

- Maestro 1 Soapstone
- Maestro 1 Indian Night
- Maestro 1 Indian Night – Magic door
- Maestro 2 Soapstone
- Maestro 2 Soapstone – Magic door
- Maestro 2 Indian Night
- Maestro 2 Indian Night – Magic door

### Accessories:

- Extra stones for rear exhaustion
- Shaped glass floor plate
- Universal glass floor plate black

 **LOTUS**  
QUALITY FIRST

**LOTUS HEATING SYSTEMS AS**

Tlf. +45 6323 7070





www.lotusstoves.com

Email info@lotusstoves.com



# Maestro 1 Magic door

A+

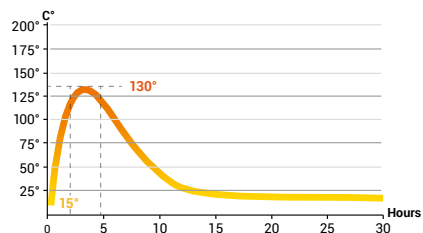

-  420 kg
-  12 Pa
-  6 kW
-  4-10 kW
-  30 - 120 m<sup>2</sup>



- Mg/M<sup>3</sup>** 31
-  1,7 kg
-  83,5%



# Maestro 1 Magic door

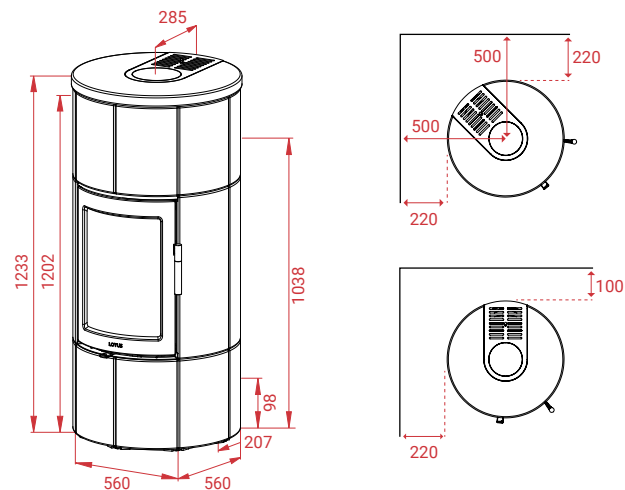

See the stoves online:



### Other models in the series:

- Maestro 1 Soapstone
- Maestro 1 Indian Night
- Maestro 1 Indian Night – Magic door
- Maestro 2 Soapstone
- Maestro 2 Soapstone – Magic door
- Maestro 2 Indian Night
- Maestro 2 Indian Night – Magic door

### Accessories:

- Extra stones for rear exhaustion
- Shaped glass floor plate
- Universal glass floor plate black



**LOTUS HEATING SYSTEMS AS**





Tlf. +45 6323 7070  
www.lotusstoves.com  
Email info@lotusstoves.com

# Maestro 1 Indian Night



## Black door

A+

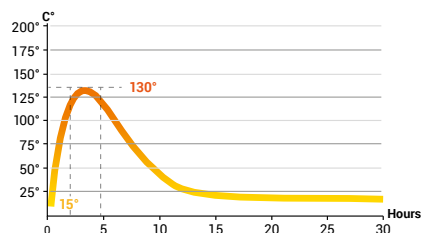

-  420 kg
-  12 Pa
-  6 kW
-  4-10 kW
-  30 - 120 m<sup>2</sup>



- Mg/M<sup>3</sup>** 31
-  1,7 kg
-  83,5%



# Maestro 1 Indian Night

## Black door

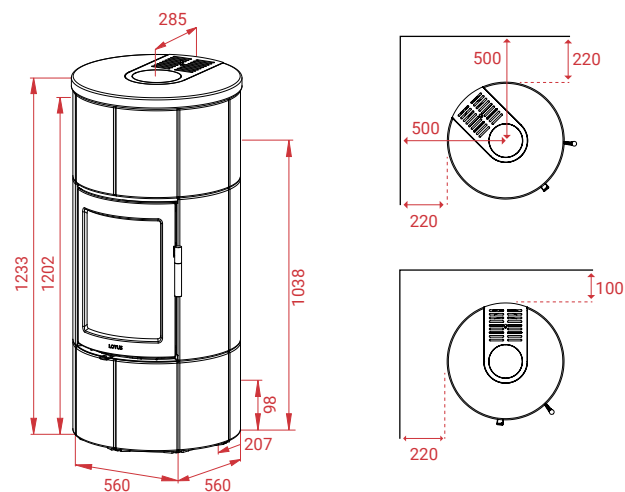

See the stoves online:



### Other models in the series:

- Maestro 1 Soapstone
- Maestro 1 Soapstone – Magic door
- Maestro 1 Indian Night – Magic door
- Maestro 2 Soapstone
- Maestro 2 Soapstone – Magic door
- Maestro 2 Indian Night
- Maestro 2 Indian Night – Magic door

### Accessories:

- Extra stones for rear exhaustion
- Shaped glass floor plate
- Universal glass floor plate black



**LOTUS HEATING SYSTEMS AS**

Tlf. +45 6323 7070  
 www.lotusstoves.com  
 Email info@lotusstoves.com

# Maestro 1 Indian Night

## Grey door

A+

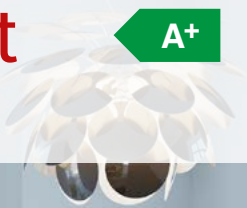

10 years Guarantee



- 420 kg
- 12 Pa
- 6 kW
- 4-10 kW
- 30 - 120 m<sup>2</sup>

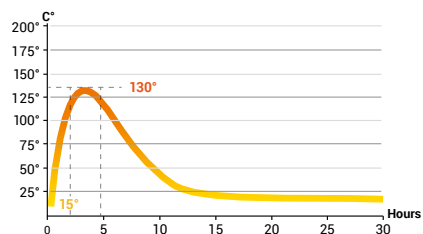

- Mg/M<sup>3</sup> 31
- 1,7 kg
- 83,5%

**LOTUS**  
QUALITY FIRST

# Maestro 1 Indian Night

## Grey door

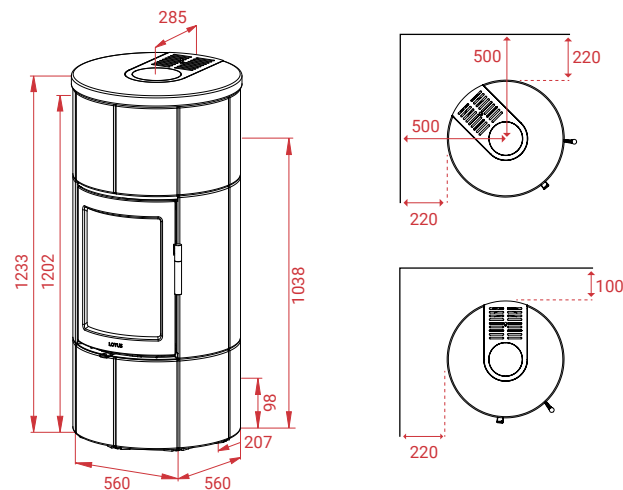

See the stoves online:



### Other models in the series:

- Maestro 1 Soapstone
- Maestro 1 Soapstone – Magic door
- Maestro 1 Indian Night – Magic door
- Maestro 2 Soapstone
- Maestro 2 Soapstone – Magic door
- Maestro 2 Indian Night
- Maestro 2 Indian Night – Magic door

### Accessories:

- Extra stones for rear exhaustion
- Shaped glass floor plate
- Universal glass floor plate black

**LOTUS**  
QUALITY FIRST

**LOTUS HEATING SYSTEMS AS**

Tlf. +45 6323 7070

www.lotusstoves.com





Email info@lotusstoves.com

# Maestro 1 Indian Night Magic door



A+

10  
years  
Guarantee

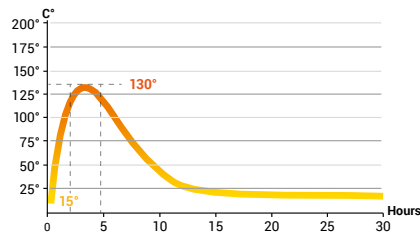

-  420 kg
-  12 Pa
-  6 kW
-  4-10 kW
-  30 - 120 m<sup>2</sup>



- Mg/M<sup>3</sup>** 31
-  1,7 kg
-  83,5%

 **LOTUS**  
QUALITY FIRST

# Maestro 1 Indian Night Magic door

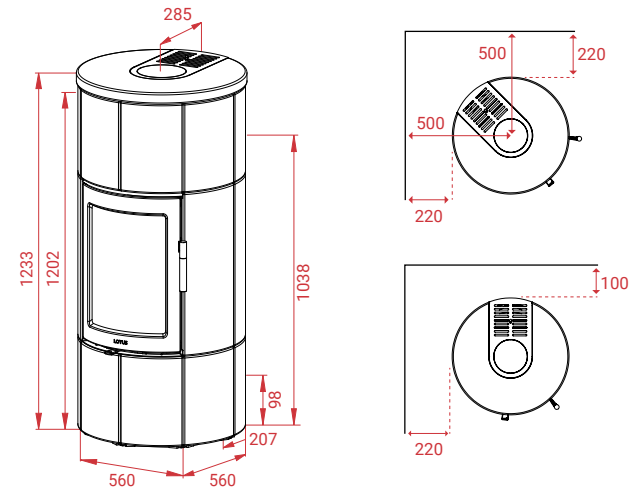

See the stoves online:



## Other models in the series:

- Maestro 1 Soapstone
- Maestro 1 Soapstone – Magic door
- Maestro 1 Indian Night
- Maestro 2 Soapstone
- Maestro 2 Soapstone – Magic door
- Maestro 2 Indian Night
- Maestro 2 Indian Night – Magic door

## Accessories:

- Extra stones for rear exhaustion
- Shaped glass floor plate
- Universal glass floor plate black

 **LOTUS**  
QUALITY FIRST

**LOTUS HEATING SYSTEMS AS**

Tlf. +45 6323 7070

www.lotusstoves.com

Email info@lotusstoves.com





# Maestro 2

## Black door



A+

10  
years  
Guarantee

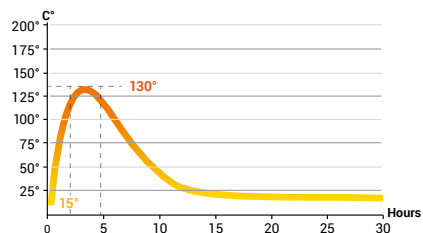

-  530 kg
-  12 Pa
-  6 kW
-  4-10 kW
-  30 - 120 m<sup>2</sup>



- Mg/M<sup>3</sup>** 31
-  1,7 kg
-  83,5%



 **LOTUS**  
QUALITY FIRST

# Maestro 2

## Black door

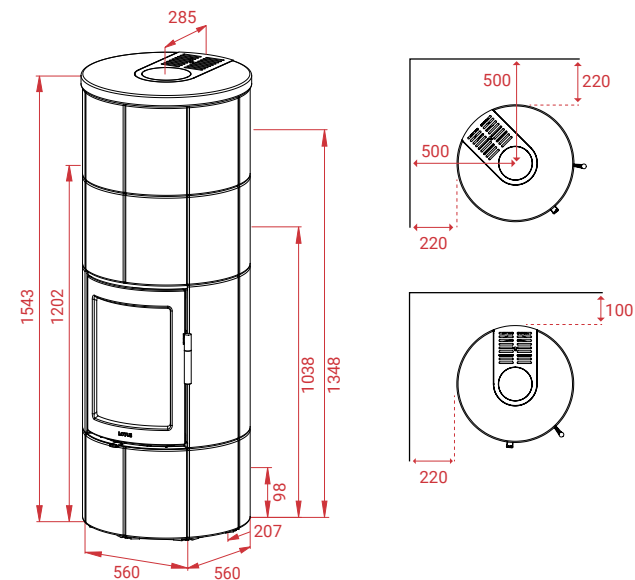

See the stoves online:



### Other models in the series:

- Maestro 1 Soapstone
- Maestro 1 Soapstone – Magic door
- Maestro 1 Indian Night
- Maestro 1 Indian Night – Magic door
- Maestro 2 Soapstone – Magic door
- Maestro 2 Indian Night
- Maestro 2 Indian Night – Magic door

### Accessories:

- Extra stones for rear exhaustion
- M9 - Baking section
- Shaped glass floor plate
- Universal glass floor plate black

 **LOTUS**  
QUALITY FIRST

**LOTUS HEATING SYSTEMS AS**

Tlf. +45 6323 7070

www.lotusstoves.com

Email info@lotusstoves.com





# Maestro 2

## Grey door



A+

10 years  
Guarantee

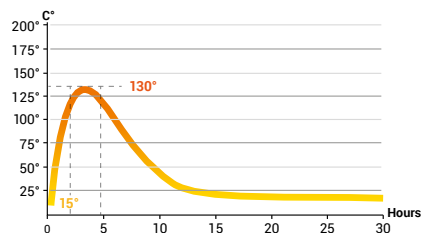

-  530 kg
-  12 Pa
-  6 kW
-  4-10 kW
-  30 - 120 m<sup>2</sup>



- Mg/M<sup>3</sup>** 31
-  1,7 kg
-  83,5%

 **LOTUS**  
QUALITY FIRST

# Maestro 2

## Grey door

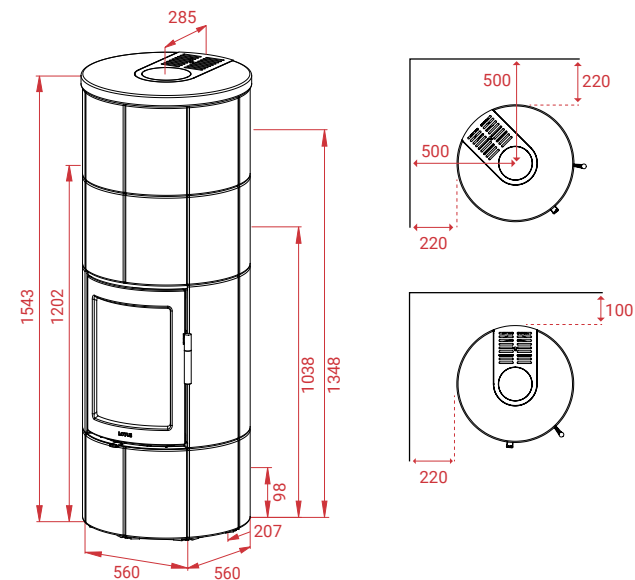

### Other models in the series:

- Maestro 1 Soapstone
- Maestro 1 Soapstone – Magic door
- Maestro 1 Indian Night
- Maestro 1 Indian Night – Magic door
- Maestro 2 Soapstone – Magic door
- Maestro 2 Indian Night
- Maestro 2 Indian Night – Magic door

### Accessories:

- Extra stones for rear exhaustion
- M9 - Baking section
- Shaped glass floor plate
- Universal glass floor plate black

See the stoves online:



 **LOTUS**  
QUALITY FIRST

**LOTUS HEATING SYSTEMS AS**

Tlf. +45 6323 7070

www.lotusstoves.com

Email info@lotusstoves.com







# Maestro 2

## Magic door



A+

10  
years  
Guarantee

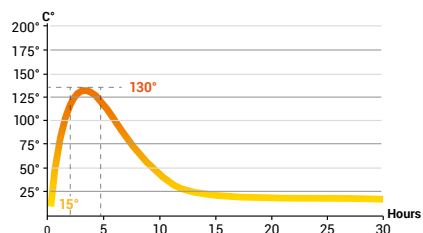

-  530 kg
-  12 Pa
-  6 kW
-  4-10 kW
-  30 - 120 m<sup>2</sup>



- Mg/M<sup>3</sup>** 31
-  1,7 kg
-  83,5%



 **LOTUS**  
QUALITY FIRST

# Maestro 2

## Magic door

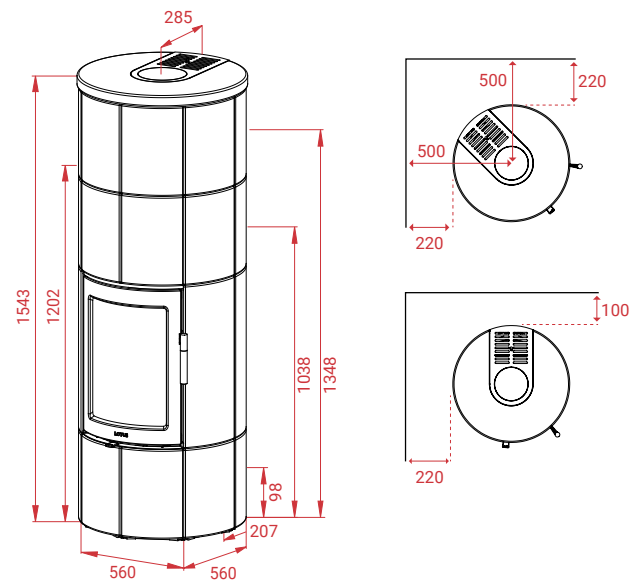

See the stoves online:



### Other models in the series:

- Maestro 1 Soapstone
- Maestro 1 Soapstone – Magic door
- Maestro 1 Indian Night
- Maestro 1 Indian Night – Magic door
- Maestro 2 Soapstone
- Maestro 2 Indian Night
- Maestro 2 Indian Night – Magic door

### Accessories:

- Extra stones for rear exhaustion
- M9 - Baking section
- Shaped glass floor plate
- Universal glass floor plate black

 **LOTUS**  
QUALITY FIRST

**LOTUS HEATING SYSTEMS AS**

Tlf. +45 6323 7070

www.lotusstoves.com

Email info@lotusstoves.com

# Maestro 2 Indian Night

## Black door

A+

10 years Guarantee



- 530 kg
- 12 Pa
- 6 kW
- 4-10 kW
- 30 - 120 m<sup>2</sup>

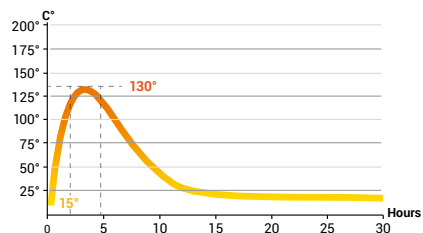

- Mg/M<sup>3</sup>** 31
- 1,7 kg
- 83,5%



**LOTUS**  
QUALITY FIRST

# Maestro 2 Indian Night

## Black door

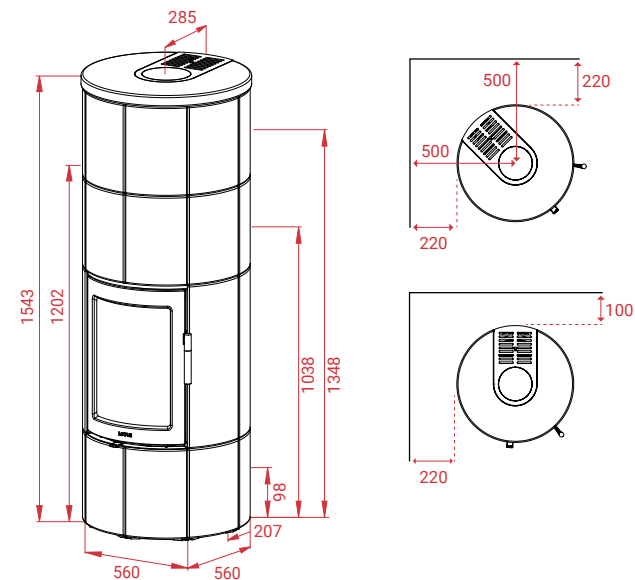

### Other models in the series:

- Maestro 1 Soapstone
- Maestro 1 Soapstone – Magic door
- Maestro 1 Indian Night
- Maestro 1 Indian Night – Magic door
- Maestro 2 Soapstone
- Maestro 2 Soapstone – Magic door
- Maestro 2 Indian Night – Magic door

### Accessories:

- Extra stones for rear exhaustion
- M9 - Baking section
- Shaped glass floor plate
- Universal glass floor plate black

See the stoves online:



**LOTUS**  
QUALITY FIRST

**LOTUS HEATING SYSTEMS AS**

Tlf. +45 6323 7070

www.lotusstoves.com

Email info@lotusstoves.com





# Maestro 2 Indian Night

## Grey door



A+

10 years Guarantee

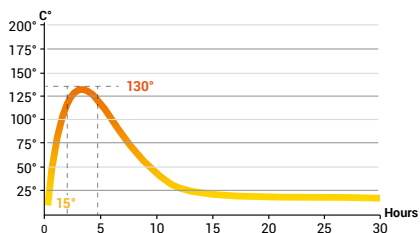

-  530 kg
-  12 Pa
-  6 kW
-  4-10 kW
-  30 - 120 m<sup>2</sup>



- Mg/M<sup>3</sup>** 31
-  1,7 kg
-  83,5%

 **LOTUS**  
QUALITY FIRST

# Maestro 2 Indian Night

## Grey door

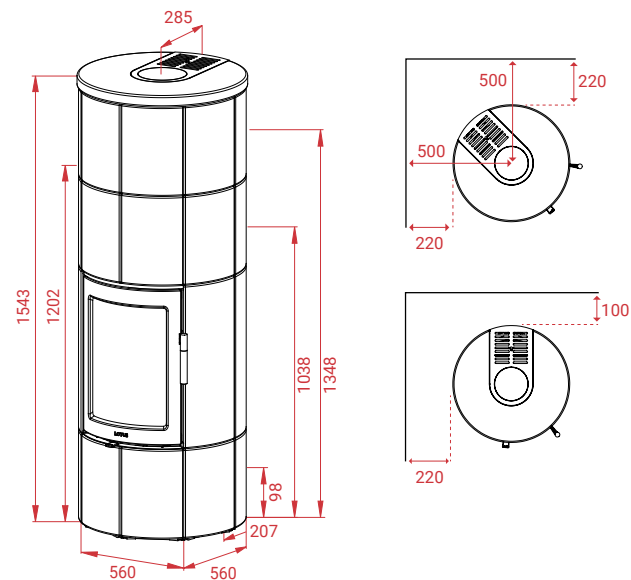

See the stoves online:



### Other models in the series:

- Maestro 1 Soapstone
- Maestro 1 Soapstone – Magic door
- Maestro 1 Indian Night
- Maestro 1 Indian Night – Magic door
- Maestro 2 Soapstone
- Maestro 2 Soapstone – Magic door
- Maestro 2 Indian Night
- Maestro 2 Indian Night – Magic door

### Accessories:

- Extra stones for rear exhaustion
- M9 - Baking section
- Shaped glass floor plate
- Universal glass floor plate black

 **LOTUS**  
QUALITY FIRST

**LOTUS HEATING SYSTEMS AS**

Tlf. +45 6323 7070

www.lotusstoves.com





Email info@lotusstoves.com

# Maestro 2 Indian Night Magic door



A+

10  
years  
Guarantee

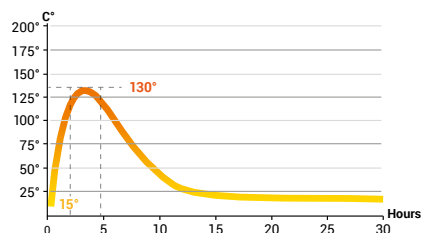

-  530 kg
-  12 Pa
-  6 kW
-  4-10 kW
-  30 - 120 m<sup>2</sup>



- Mg/M<sup>3</sup>** 31
-  1,7 kg
-  83,5%

 **LOTUS**  
QUALITY FIRST

# Maestro 2 Indian Night Magic door

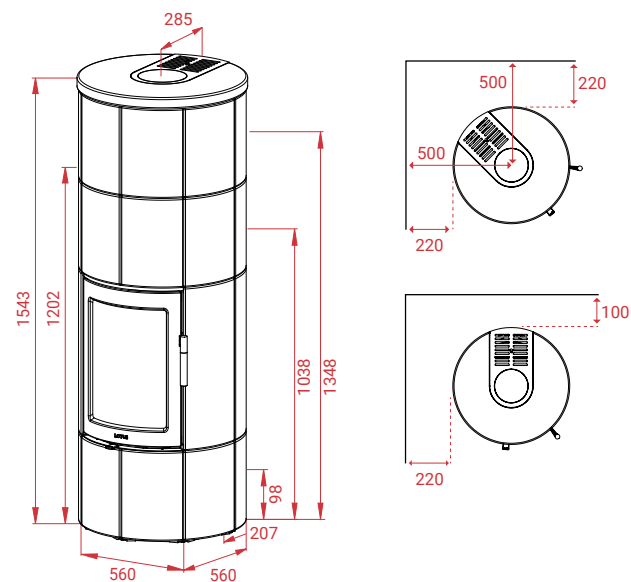

See the stoves online:



### Other models in the series:

- Maestro 1 Soapstone
- Maestro 1 Soapstone – Magic door
- Maestro 1 Indian Night
- Maestro 1 Indian Night – Magic door
- Maestro 2 Soapstone
- Maestro 2 Soapstone – Magic door
- Maestro 2 Indian Night

### Accessories:

- Extra stones for rear exhaustion
- M9 - Baking section
- Shaped glass floor plate
- Universal glass floor plate black

 **LOTUS**  
QUALITY FIRST

**LOTUS HEATING SYSTEMS AS**

Tlf. +45 6323 7070

www.lotusstoves.com





Email info@lotusstoves.com

# Maestro 2 Soapstone Baking Sektion



A+

10  
years  
Guarantee

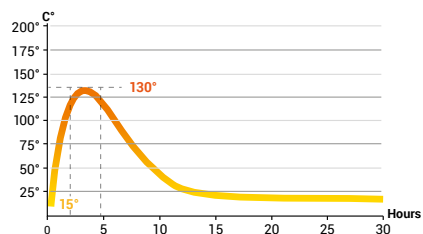

-  530 kg
-  12 Pa
-  6 kW
-  4-10 kW
-  30 - 120 m<sup>2</sup>



- Mg/M<sup>3</sup>** 31
-  1,7 kg
-  83,5%



 **LOTUS**  
QUALITY FIRST

# Maestro 2 Soapstone Baking Sektion

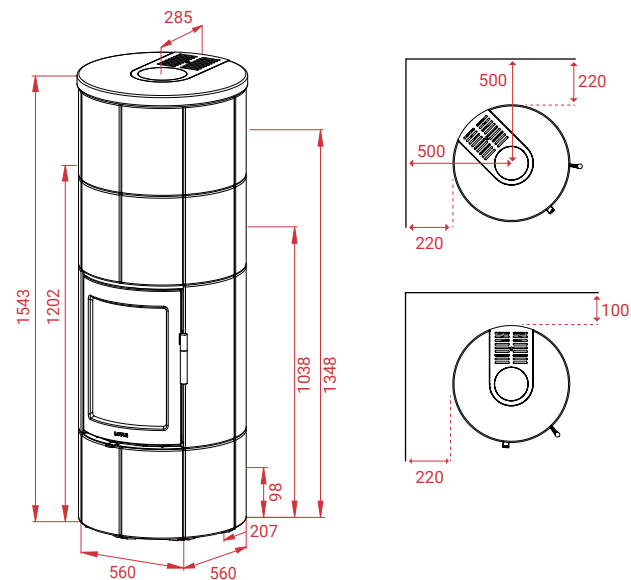

See the stoves online:



#### Other models in the series:

- Maestro 1 Soapstone
- Maestro 1 Soapstone – Magic door
- Maestro 1 Indian Night
- Maestro 1 Indian Night – Magic door
- Maestro 2 Soapstone
- Maestro 2 Soapstone – Magic door
- Maestro 2 Indian Night

#### Accessories:

- Extra stones for rear exhaustion
- M9 - Baking section
- Shaped glass floor plate
- Universal glass floor plate black

 **LOTUS**  
QUALITY FIRST

**LOTUS HEATING SYSTEMS AS**

Tlf. +45 6323 7070

www.lotusstoves.com

Email info@lotusstoves.com



# Maestro 152 M

## Black door



A+

10  
years  
Guarantee

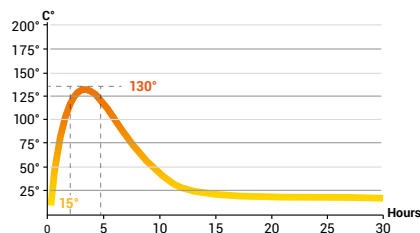

-  510 kg
-  12 Pa
-  6 kW
-  4-10 kW
-  30 - 120 m<sup>2</sup>



- Mg/M<sup>3</sup>** 31
-  1,7 kg
-  83,5%

 **LOTUS**  
QUALITY FIRST

# Maestro 152 M

## Black door

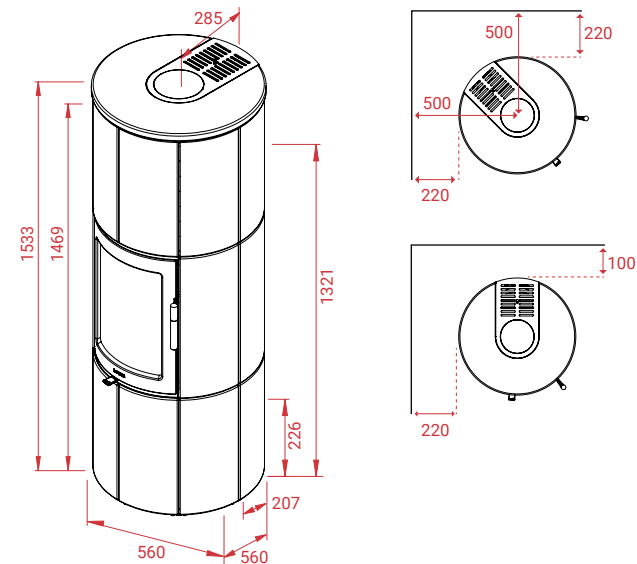

### Other models in the series:

- Maestro 152 – Grey door
- Maestro 152 – Magic door
- Maestro 152 Indian Night – Grey door
- Maestro 152 Indian Night – Black door
- Maestro 152 Indian Night – Magic door

### Accessories:

- Extra stones for rear exhaustion
- Shaped glass floor plate
- Universal glass floor plate black

See the stoves online:

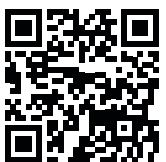

 **LOTUS**  
QUALITY FIRST

**LOTUS HEATING SYSTEMS AS**

Tlf. +45 6323 7070

www.lotusstoves.com

Email info@lotusstoves.com





# Maestro 152 M

## Grey door

A+

10  
years  
Guarantee



-  510 kg
-  12 Pa
-  6 kW
-  4-10 kW
-  30 - 120 m<sup>2</sup>

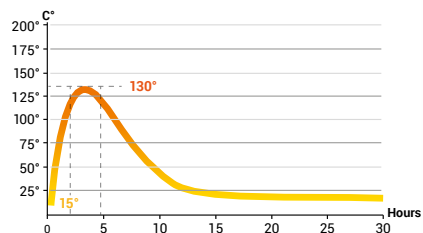

Mg/M<sup>3</sup> 31

 1,7 kg

 83,5%

 **LOTUS**  
QUALITY FIRST

# Maestro 152 M

## Grey door

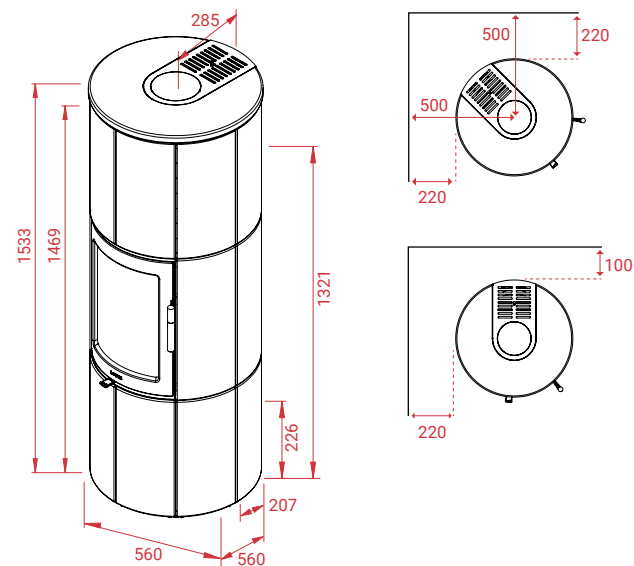

### Other models in the series:

- Maestro 152 – Black door
- Maestro 152 – Magic door Maestro
- 152 Indian Night – Grey door Maestro
- 152 Indian Night – Black door Maestro
- 152 Indian Night – Magic door

### Accessories:

- Extra stones for rear exhaustion
- Shaped glass floor plate
- Universal glass floor plate black

See the stoves online:



 **LOTUS**  
QUALITY FIRST

**LOTUS HEATING SYSTEMS AS**

Tlf. +45 6323 7070

www.lotusstoves.com

Email info@lotusstoves.com





# Maestro 152 M

## Magic door



A+

10  
years  
Guarantee

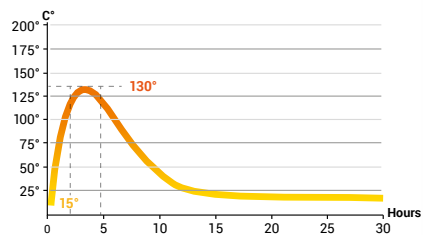

-  510 kg
-  12 Pa
-  6 kW
-  4-10 kW
-  30 - 120 m<sup>2</sup>



- Mg/M<sup>3</sup>** 31
-  1,7 kg
-  83,5%

 **LOTUS**  
QUALITY FIRST

# Maestro 152 M

## Magic door

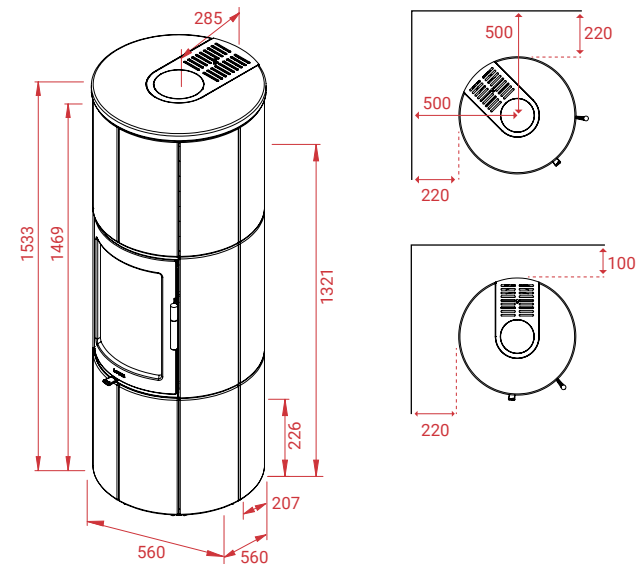

### Other models in the series:

- Maestro 152 – Grey door
- Maestro 152 – Black door
- Maestro 152 Indian Night – Grey door
- Maestro 152 Indian Night – Black door
- Maestro 152 Indian Night – Magic door

### Accessories:

- Extra stones for rear exhaustion
- Shaped glass floor plate
- Universal glass floor plate black

See the stoves online:



 **LOTUS**  
QUALITY FIRST

**LOTUS HEATING SYSTEMS AS**

Tlf. +45 6323 7070

www.lotusstoves.com

Email info@lotusstoves.com







# Maestro 152 IN

## Black door



A+

10  
years  
Guarantee

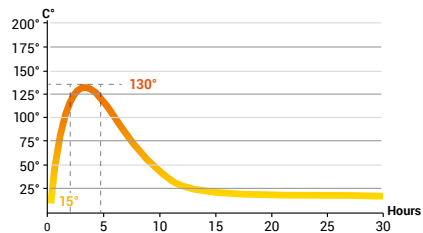

-  510 kg
-  12 Pa
-  6 kW
-  4-10 kW
-  30 - 120 m<sup>2</sup>



- Mg/M<sup>3</sup>** 31
-  1,7 kg
-  83,5%

 **LOTUS**  
QUALITY FIRST

# Maestro 152 IN

## Black door

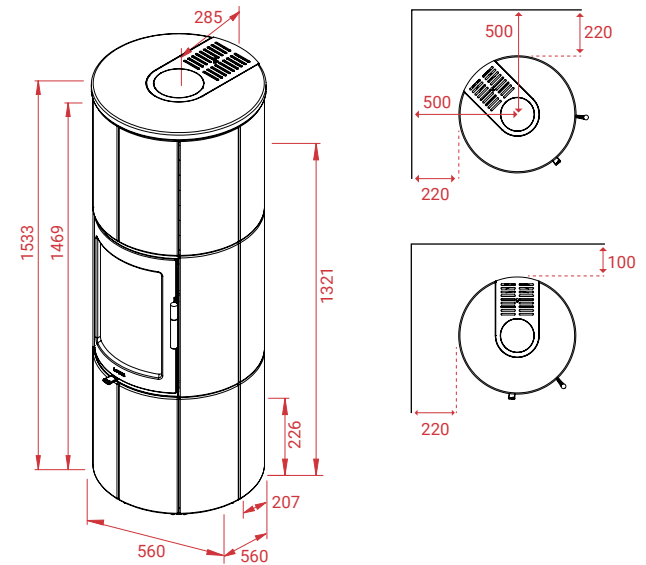

### Other models in the series:

- Maestro 152 – Grey door
- Maestro 152 – Black door
- Maestro 152 – Magic door
- Maestro 152 Indian Night – Grey door
- Maestro 152 Indian Night – Magic door

### Accessories:

- Extra stones for rear exhaustion
- Shaped glass floor plate
- Universal glass floor plate black

See the stoves online:



 **LOTUS**  
QUALITY FIRST

**LOTUS HEATING SYSTEMS AS**

Tlf. +45 6323 7070

www.lotusstoves.com

Email info@lotusstoves.com





# Maestro 152 IN

## Grey door



A+

10  
years  
Guarantee

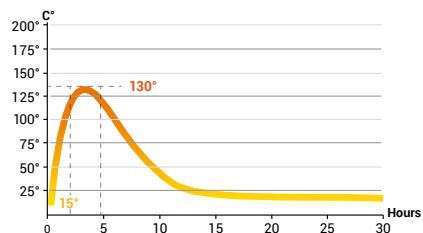

-  510 kg
-  12 Pa
-  6 kW
-  4-10 kW
-  30 - 120 m<sup>2</sup>



- Mg/M<sup>3</sup>** 31
-  1,7 kg
-  83,5%



 **LOTUS**  
QUALITY FIRST

# Maestro 152 IN

## Grey door

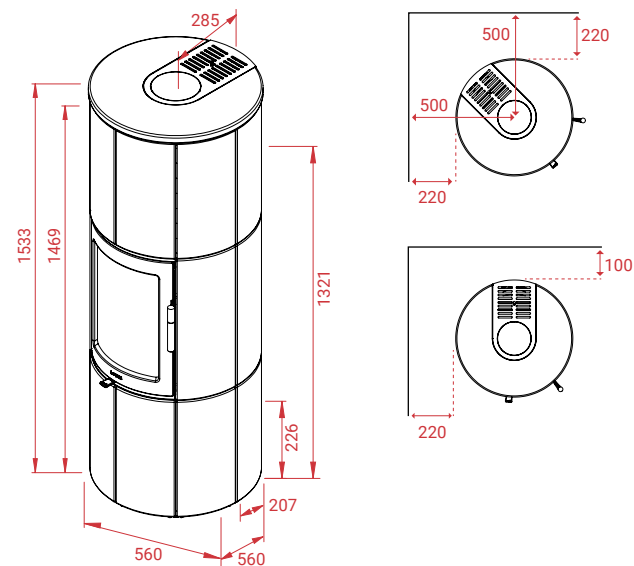

### Other models in the series:

- Maestro 152 – Grey door
- Maestro 152 – Black door
- Maestro 152 – Magic door
- Maestro 152 Indian Night – Black door
- Maestro 152 Indian Night – Magic door

### Accessories:

- Extra stones for rear exhaustion
- Shaped glass floor plate
- Universal glass floor plate black

See the stoves online:



 **LOTUS**  
QUALITY FIRST

**LOTUS HEATING SYSTEMS AS**

Tlf. +45 6323 7070

www.lotusstoves.com

Email info@lotusstoves.com





# Maestro 152 IN

## Magic door



A+

10  
years  
Guarantee

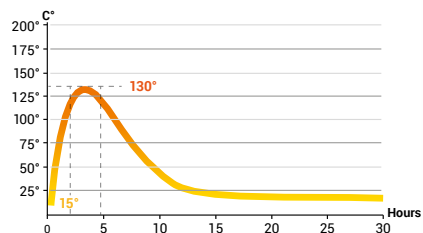

-  510 kg
-  12 Pa
-  6 kW
-  4-10 kW
-  30 - 120 m<sup>2</sup>



- Mg/M<sup>3</sup>** 31
-  1,7 kg
-  83,5%

 **LOTUS**  
QUALITY FIRST

# Maestro 152 IN

## Magic door

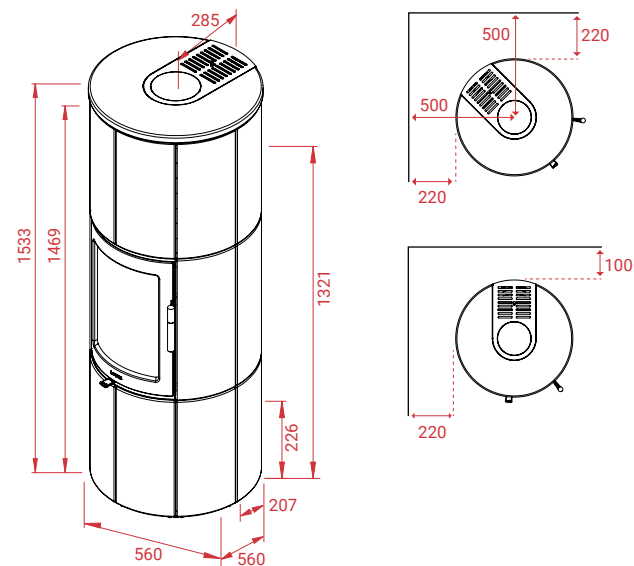

### Other models in the series:

- Maestro 152 – Grey door
- Maestro 152 – Black door
- Maestro 152 – Magic door
- Maestro 152 Indian Night – Grey door
- Maestro 152 Indian Night – Black door

### Accessories:

- Extra stones for rear exhaustion
- Shaped glass floor plate
- Universal glass floor plate black

See the stoves online:



 **LOTUS**  
QUALITY FIRST

**LOTUS HEATING SYSTEMS AS**

Tlf. +45 6323 7070

www.lotusstoves.com

Email info@lotusstoves.com