







Living

A+



-  162 kg
-  12 Pa
-  7 kW
-  3-9 kW
-  30 - 140 m²

Mg/M³ 19

 2 kg

 80,5%



Living

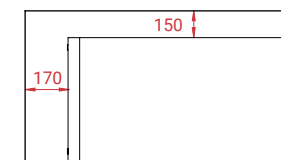
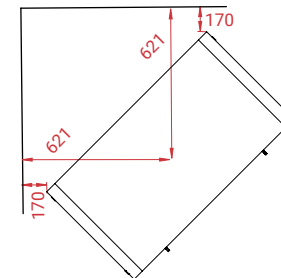
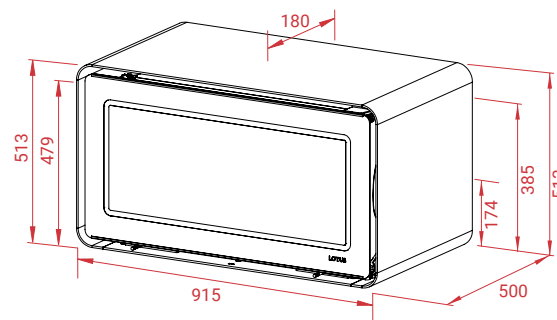

See the stoves online:



Other models in the series:

Living Cube
Living

Base

Accessories:

- Black glass for Living backside
- Glass floor plate
- H308 Outside Air pipe kit
- straight backwards or downwards (if backwards and 90° H310 is also needed)
- H310 Outside Air pipe - 90°



LOTUS HEATING SYSTEMS AS

Tlf. +45 6323 7070

www.lotusstoves.com

Email info@lotusstoves.com

Living Base

A+



- 190 kg
- 12 Pa
- 7 kW
- 3-9 kW
- 30 - 140 m²

- Mg/M³** 19
- 2 kg
- 80,5%



Living Base

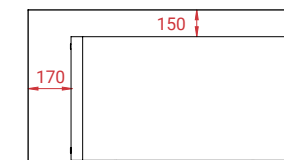
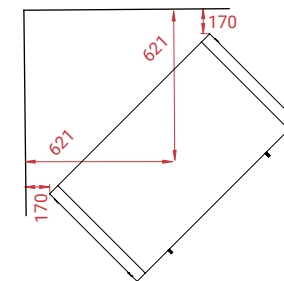
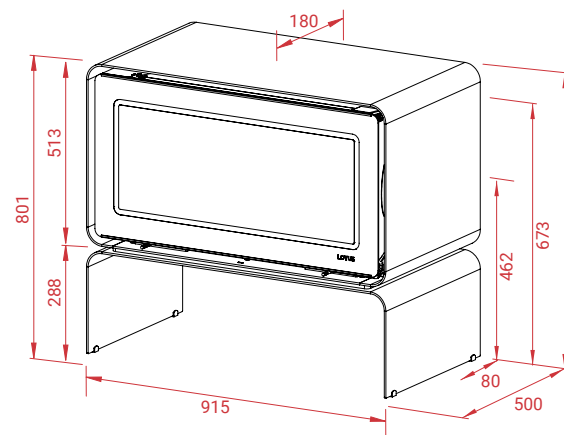

- Alpin White
- Ocean Dark
- Phantom Grey



Other models in the series:

- Living Cube
- Living

Accessories:

- Black glass for Living backside
- Glass floor plate
- Glass plate in front legs
- H308 Outside Air pipe kit
- straight backwards or downwards (if backwards and 90° H310 is also needed)
- H310 Outside Air pipe - 90°

See the stoves online:



LOTUS HEATING SYSTEMS AS

Tlf. +45 6323 7070





www.lotusstoves.com



Email info@lotusstoves.com

Living Cube

A+







-  211 kg
-  12 Pa
-  7 kW
-  3-9 kW
-  30 - 140 m²

- Mg/M³** 19
-  2 kg
-  80,5%

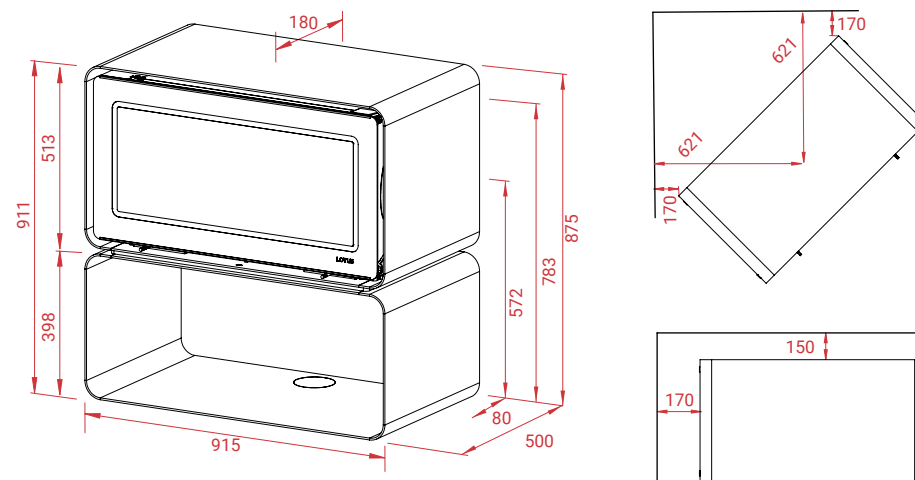

Living Cube



-  Alpin White
-  Ocean Dark
-  Phantom Grey



Other models in the series:

Living Base
Living

Accessories:

Black glass for Living backside
Black glass or steel plate for Cube socket
Glass plate in front Living Cube
H308 Outside Air pipe kit
- straight backwards or downwards
(if backwards and 90° H310 is also needed)
H310 Outside Air pipe - 90°

See the stoves online:



LOTUS HEATING SYSTEMS AS

Tlf. +45 6323 7070

www.lotusstoves.com

Email info@lotusstoves.com