







# Unico 11

A+

10 years  
Guarantee



-  122 kg
-  12 Pa
-  6 kW
-  4-9 kW
-  30 - 150 m<sup>2</sup>

- Mg/M<sup>3</sup>** 33
-  1,8 kg
-  80%

 **LOTUS**  
QUALITY FIRST

# Unico 11

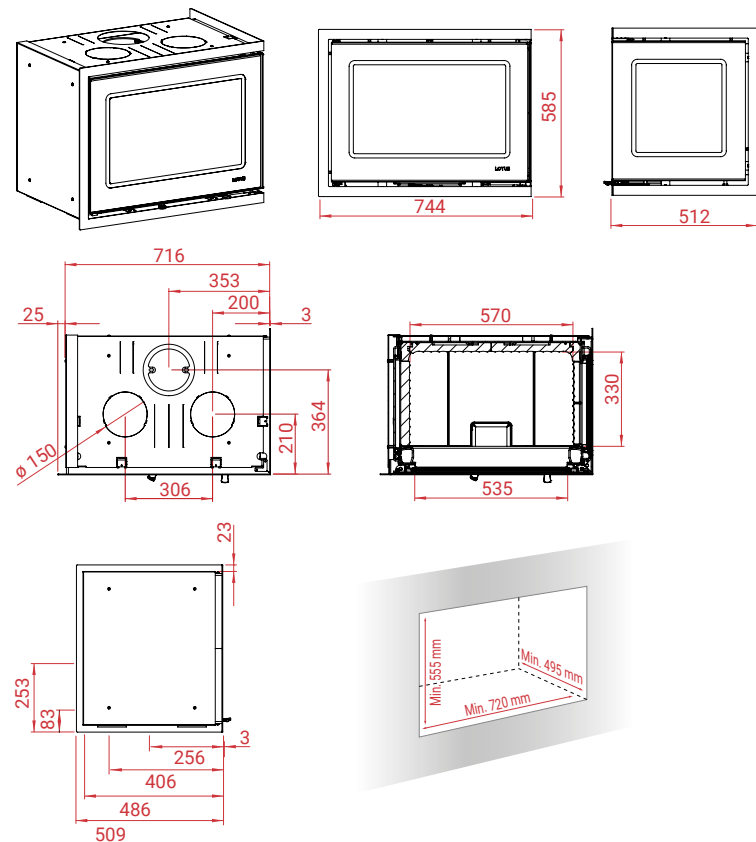

### Other models in the series:

Unico 12  
Unico 13

### Accessories:

Unico Base  
Black Magic frame  
H309 Outside Air pipe kit  
- straight backwards or downwards  
(if backwards and 90° H310 is also needed)  
H310 Outside Air pipe - 90°  
H499 Connection pieces for air ducts Ø150mm (2 pcs)

See the stoves online:



 **LOTUS**  
QUALITY FIRST

**LOTUS HEATING SYSTEMS AS**

Tlf. +45 6323 7070

www.lotusstoves.com





Email info@lotusstoves.com



# Unico 12

A+

10 years  
Guarantee



-  122 kg
-  12 Pa
-  6 kW
-  4-9 kW
-  30 - 150 m<sup>2</sup>

- Mg/M<sup>3</sup>** 33
-  1,8 kg
-  80%

 **LOTUS**  
QUALITY FIRST

# Unico 12

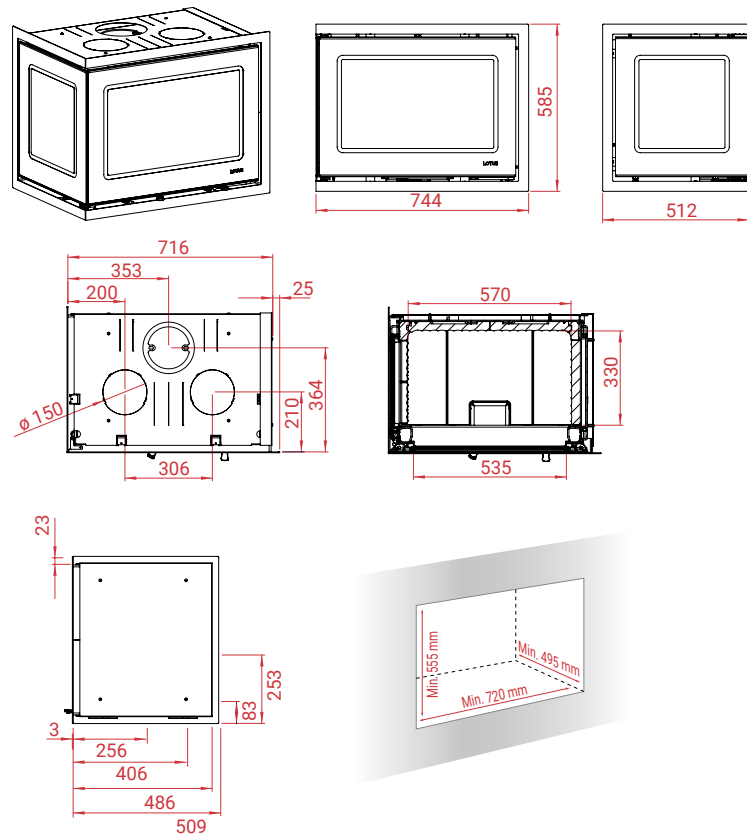

## Other models in the series:

Unico 11  
Unico 13

## Accessories:

Unico Base  
Black Magic frame  
H309 Outside Air pipe kit  
- straight backwards or downwards  
(if backwards and 90° H310 is also needed)  
H310 Outside Air pipe - 90°  
H499 Connection pieces for air ducts Ø150mm (2 pcs)

See the stoves online:



 **LOTUS**  
QUALITY FIRST

**LOTUS HEATING SYSTEMS AS**

Tlf. +45 6323 7070

www.lotusstoves.com





Email info@lotusstoves.com

# Unico 13

A+

10 years  
Guarantee



-  122 kg
-  12 Pa
-  6 kW
-  4-9 kW
-  30 - 150 m<sup>2</sup>

**Mg/M<sup>3</sup>** 33

 1,8 kg

 80%

 **LOTUS**  
QUALITY FIRST

# Unico 13

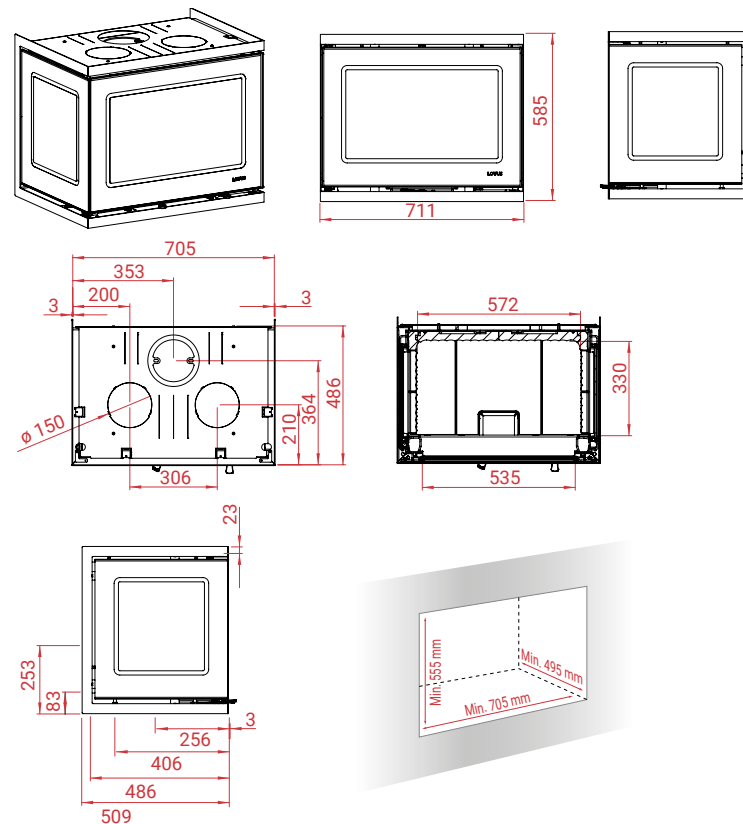

### Other models in the series:

- Unico 11
- Unico 12

### Accessories:

- Unico Base
- Black Magic frame
- H309 Outside Air pipe kit
  - straight backwards or downwards (if backwards and 90° H310 is also needed)
- H310 Outside Air pipe - 90°
- H499 Connection pieces for air ducts  $\phi 150$ mm (2 pcs)

See the stoves online:



 **LOTUS**  
QUALITY FIRST

**LOTUS HEATING SYSTEMS AS**

Tlf. +45 6323 7070

www.lotusstoves.com

Email info@lotusstoves.com